

# LI-210R

# Photometric Sensor

Instruction Manual



**LI-COR®**



# **LI-210R Photometric Sensor Instruction Manual**

**Publication Number 984-15209**

**LI-COR<sup>®</sup>, Inc.  
4647 Superior Street  
Lincoln, Nebraska 68504 USA  
Telephone: (402) 467-3576**

**FAX: 402-467-2819  
Toll Free: 1-800-447-3576 (U.S. & Canada)  
envsales@licor.com  
[www.licor.com/env/support/](http://www.licor.com/env/support/)  
[www.licor.com](http://www.licor.com)**

## NOTICE

The information contained in this document is subject to change without notice.

LI-COR® MAKES NO WARRANTY OF ANY KIND WITH REGARD TO THIS MATERIAL, INCLUDING, BUT NOT LIMITED TO THE IMPLIED WARRANTIES OF MERCHANTABILITY AND FITNESS FOR A PARTICULAR PURPOSE. LI-COR shall not be liable for errors contained herein or for incidental or consequential damages in connection with the furnishing, performance, or use of this material.

This document contains proprietary information which is protected by copyright. All rights are reserved. No part of this document may be reproduced or translated into another language with prior written consent of LI-COR, Inc.

All other trademarks or registered trademarks are property of their respective owners.

© Copyright 2015, LI-COR, Inc.

LI-COR, Inc.  
4647 Superior Street  
Lincoln, NE 68504

Phone: 402-467-3576  
Toll Free (U.S. and Canada): 1-800-447-3576

In Germany - LI-COR GmbH: +49 (0) 6172 17 17 771

[www.licor.com/env](http://www.licor.com/env)  
[envsales@licor.com](mailto:envsales@licor.com)

This product is a CE-marked product. For conformity information, contact LI-COR Support at [envsupport@licor.com](mailto:envsupport@licor.com). Outside of the U.S., contact your local sales office or distributor.

This device complies with part 15 of the FCC Rules. Operation is subject to the following two conditions: (1) This device may not cause harmful interference, and (2) this device must accept any interference received, including interference that may cause undesired operation.

## Printing History

Publication Number: 984-15209

New editions of this manual will include all updates. An update addendum may be used between editions to provide up-to-date information. Revisions are indicated by the revision number. Minor updates, which do not alter the meaning of the content, will be incorporated without affecting the revision number.

<b>Version Number</b>	<b>Publication Date</b>	<b>Changes</b>
1	April, 2015	First Edition
2	May, 2015	Second Edition; Edited Troubleshooting section

Build Date: Friday, May 08, 2015

LI-210R-BL-x; LI-210R-BNC-x (x = 2, 5, 15, 50)						
Component Name	Hazardous Substances or Elements					
	Lead (Pb)	Mercury (Hg)	Cadmium (Cd)	Chromium VI Compounds (Cr <sup>6+</sup> )	Polybrominated Biphenyls (PBB)	Polybrominated Diphenyl Ethers (PBDE)
Photometric Sensor Head Assembly	X	O	O	O	O	O
Base and Cable Assembly	X	O	O	O	O	O
O: this component does not contain this hazardous substance above the maximum concentration values in homogeneous materials specified in the SJ/T 11363-2006 Industry Standard.						
X: this component does contain this hazardous substance above the maximum concentration values in homogeneous materials specified in the SJ/T 11363-2006 Industry Standard (Company can explain the technical reasons for the "X")						
LI-210R-BL-x; LI-210R-BNC-x (x = 2, 5, 15, 50)						
部件名称	有毒有害物质或元素					
	铅 (Pb)	汞 (Hg)	镉 (Cd)	六价铬 (Cr <sup>6+</sup> )	多溴联苯 (PBB)	多溴二苯醚 (PBDE)
测光传感器头组件	X	O	O	O	O	O
底座和电缆组件	X	O	O	O	O	O
O: 表示该有毒有害物质在该部件所有均质材料中的含量均在 SJ/T 11363-2006 标准规定的限量要求以下。						
X: 表示该有毒有害物质至少在该部件的某一均质材料中的含量超出 SJ/T 11363-2006 标准规定的限量要求。(企业可在此处, 根据实际情况对上表中打 "X" 的技术原因进行进一步的说明。)						

Doc. #53-14983 March 23, 2015

LI-210R-SMV-x (x = 2, 5, 15, 50)						
Component Name	Hazardous Substances or Elements					
	Lead (Pb)	Mercury (Hg)	Cadmium (Cd)	Chromium VI Compounds (Cr <sup>6+</sup> )	Polybrominated Biphenyls (PBB)	Polybrominated Diphenyl Ethers (PBDE)
Millivolt Adapter Assembly	X	O	O	O	O	O
Photometric Sensor Head Assembly	X	O	O	O	O	O
Base and Cable Assembly	X	O	O	O	O	O
O: this component does not contain this hazardous substance above the maximum concentration values in homogeneous materials specified in the SJ/T 11363-2006 Industry Standard.						
X: this component does contain this hazardous substance above the maximum concentration values in homogeneous materials specified in the SJ/T 11363-2006 Industry Standard (Company can explain the technical reasons for the "X")						
LI-210R-SMV-x (x = 2, 5, 15, 50)						
部件名称	有毒有害物质或元素					
	铅 (Pb)	汞 (Hg)	镉 (Cd)	六价铬 (Cr <sup>6+</sup> )	多溴联苯 (PBB)	多溴二苯醚 (PBDE)
毫伏适配器组件	X	O	O	O	O	O
测光传感器头组件	X	O	O	O	O	O
底座和电缆组件	X	O	O	O	O	O
O: 表示该有毒有害物质在该部件所有均质材料中的含量均在 SJ/T 11363-2006 标准规定的限量要求以下。						
X: 表示该有毒有害物质至少在该部件的某一均质材料中的含量超出 SJ/T 11363-2006 标准规定的限量要求。(企业可在此处, 根据实际情况对上表中打 "X" 的技术原因进行进一步的说明。)						

Doc. #53-15082 March 23, 2015

2420-BL						
Component Name	Hazardous Substances or Elements					
	Lead (Pb)	Mercury (Hg)	Cadmium (Cd)	Chromium VI Compounds (Cr <sup>6+</sup> )	Polybrominated Biphenyls (PBB)	Polybrominated Diphenyl Ethers (PBDE)
Amplifier Bare Lead Assembly	X	O	O	O	O	O
O: this component does not contain this hazardous substance above the maximum concentration values in homogeneous materials specified in the SJ/T 11363-2006 Industry Standard.						
X: this component does contain this hazardous substance above the maximum concentration values in homogeneous materials specified in the SJ/T 11363-2006 Industry Standard (Company can explain the technical reasons for the "X")						
2420-BL						
部件名称	有毒有害物质或元素					
	铅 (Pb)	汞 (Hg)	镉 (Cd)	六价铬 (Cr <sup>6+</sup> )	多溴联苯 (PBB)	多溴二苯醚 (PBDE)
放大器裸导线总成	X	O	O	O	O	O
O: 表示该有毒有害物质在该部件所有均质材料中的含量均在 SJ/T 11363-2006 标准规定的限量要求以下。						
X: 表示该有毒有害物质至少在该部件的某一均质材料中的含量超出 SJ/T 11363-2006 标准规定的限量要求。(企业可在此处, 根据实际情况对上表中打 "X" 的技术原因进行进一步的说明。)						

Doc. #53-14832 March 23, 2015

2420-BNC						
Component Name	Hazardous Substances or Elements					
	Lead (Pb)	Mercury (Hg)	Cadmium (Cd)	Chromium VI Compounds (Cr <sup>6+</sup> )	Polybrominated Biphenyls (PBB)	Polybrominated Diphenyl Ethers (PBDE)
Amplifier BNC Assembly	X	O	O	O	O	O
O: this component does not contain this hazardous substance above the maximum concentration values in homogeneous materials specified in the SJ/T 11363-2006 Industry Standard.						
X: this component does contain this hazardous substance above the maximum concentration values in homogeneous materials specified in the SJ/T 11363-2006 Industry Standard (Company can explain the technical reasons for the "X")						
2420-BNC						
部件名称	有毒有害物质或元素					
	铅 (Pb)	汞 (Hg)	镉 (Cd)	六价铬 (Cr <sup>6+</sup> )	多溴联苯 (PBB)	多溴二苯醚 (PBDE)
放大器BNC大会	X	O	O	O	O	O
O: 表示该有毒有害物质在该部件所有均质材料中的含量均在 SJ/T 11363-2006 标准规定的限量要求以下。						
X: 表示该有毒有害物质至少在该部件的某一均质材料中的含量超出 SJ/T 11363-2006 标准规定的限量要求。(企业可在此处, 根据实际情况对上表中打 "X" 的技术原因进行进一步的说明。)						

Doc. #53-14833 March 23, 2015

# Table of Contents

---

## Section 1. General Information

---

Comparing LI-COR® Radiation Sensors .....	1-1
Cable Options .....	1-2
Accessories .....	1-3
Configurations .....	1-3

---

## Section 2. Using the LI-210R Photometric Sensor

---

Mounting .....	2-1
Calibration Constants and Multipliers .....	2-2
Using the LI-210R-BNC Photometric Sensor .....	2-3
Using the LI-210R-BL Photometric Sensor .....	2-3
Voltage Signal Options .....	2-4

---

## Section 3. Millivolt Adapters

---

2290 Millivolt Adapter .....	3-1
Connecting the 2290 Millivolt Adapter .....	3-2
LI-210R-SMV Photometric Sensor .....	3-2
Connecting the LI-210R-SMV Photometric Sensor .....	3-3

---

## Section 4. 2420 Light Sensor Amplifier

---

2420 Amplifier Gain Settings .....	4-1
Connecting to a Data Logger .....	4-4
Connecting to a Sensor .....	4-6
Equation Summary .....	4-7
Output Voltage .....	4-7
Ideal Gain .....	4-7
Voltage Multiplier .....	4-7
2420 Amplifier Performance Characteristics .....	4-8
Output .....	4-8
2420 Amplifier Specifications .....	4-8

---

## Section 5. Performance Characteristics

---



Cosine Response .....	5-1
LI-210R Cosine Correction .....	5-1
Spectral Response .....	5-3
Calibration .....	5-3

---

## **Section 6. Care and Maintenance**

---

Factory Recalibration .....	6-2
Removing a Cable .....	6-2
Sensor Base Cover .....	6-3
Installing a Cable .....	6-3
Replacement Parts .....	6-4

---

## **Section 7. Troubleshooting**

---

### **Appendix A. Specifications**

---

LI-210R Photometric Sensor Specifications .....	A-1
---	-----

---

### **Appendix B. Warranty**

---

### **Appendix C. Index**

---



# Section 1.

## General Information

This manual provides basic operating instructions for the LI-210R Photometric Sensor and its accessories. The LI-210R measures visible radiation (light as perceived by the human eye) with a silicon photodiode mounted under a cosine-corrected acrylic diffuser. The sensor output is a current ( $\mu\text{A}$ ) signal that is directly proportional to hemispherical light. A multiplier is used to convert the current signal into units of radiation (klux).



### Comparing LI-COR® Radiation Sensors

Each LI-COR radiation sensor is optimized for a particular application and measurement type (Table 1-1). LI-192SA and LI-193SA sensors are submersible, but they can also be used in the atmosphere. The LI-191R Line Quantum Sensor is often used within plant canopies. LI-190R, LI-200R, and LI-210R sensors consist of a sensor head attached to a removable base and cable assembly.

**Table 1-1.** LI-COR radiation sensors.

Sensor	Measurement	Units	Waveband
LI-190R Quantum Sensor	Photosynthetically active radiation (PAR)	$\mu\text{mol s}^{-1} \text{m}^{-2}$	400 to 700 nm
LI-191R Line Quantum Sensor			
LI-192SA Underwater Quantum Sensor			
LI-193SA Underwater Spherical Quantum Sensor			
LI-200R Pyranometer	Global solar radiation	$\text{W m}^{-2}$	400 to 1100 nm
LI-210R Photometric Sensor	Light as perceived by the human eye	Lux or klux	450 to 650 nm



Figure 1-1. LI-COR radiation sensors.

## Cable Options

The detachable base and cable assembly provides benefits including:

- Reduced cost of cable repairs
- The ability to replace or recalibrate a light sensor without removing the cable from the mounting structure
- Cable interchangeability with any LI-190R, LI-200R, or LI-210R sensor head

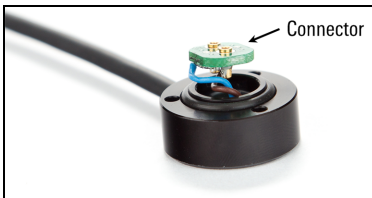

Figure 1-2. Sensor base and cable assembly detached from the sensor head.

The shielded cable leading from the sensor base terminates with either bare wire leads or a weather-resistant, nickel-plated brass BNC connector (Figure 1-3). For sensors with a BNC connector, the body of the connector carries a positive signal and is connected to the shield of the cable, while the center conductor is negative. This arrangement reduces electronic interference.



Figure 1-3. Sensor Terminal Types.

BNC or bare leads (BL) terminal types are available with cable lengths of 2, 5, 15, or 50 meters.

Calibrated LI-190R, LI-200R, or LI-210R sensor heads (without cables) are available for purchase from LI-COR. Sensor heads can replace damaged heads, or be used as spares.

Any base and cable assembly can be used interchangeably with any LI-190R, LI-200R, or LI-210R sensor head.



## Accessories

These optional accessories are available for use with the LI-210R Photometric Sensor:

- **2290 Millivolt Adapter:** 604  $\Omega$  resistance (see page 3-1)
- **2420 Light Sensor Amplifier** (see page 4-1)
- **2003S Mounting and Leveling Fixture:** Anodized aluminum with stainless steel leveling screws and a weatherproof spirit level
- **2001S Sensor Base Cover:** Anodized aluminum

## Configurations

The LI-210R Photometric Sensor connects directly to devices that read a current ( $\mu\text{A}$ ) sensor signal (Table 1-2). Table 1-3 lists configurations for producing a voltage signal.

**Table 1-2.** Configurations for a current ( $\mu\text{A}$ ) signal. Ultimate termination is BNC or bare leads.

Sensor Termination Type	Connects to...
<b>LI-210R-BNC</b>	<ul style="list-style-type: none"> <li>• LI-1500 Light Sensor Logger</li> <li>• LI-1400 Datalogger</li> <li>• LI-250A Light Meter</li> </ul>
<b>LI-210R-BL</b>	<ul style="list-style-type: none"> <li>• Terminal block of the LI-1400 Datalogger</li> <li>• Non-LI-COR devices that read a current (<math>\mu\text{A}</math>) signal</li> </ul>

**Table 1-3.** Configurations for a voltage signal. Ultimate termination is bare leads.

<b>Sensor Termination Type</b>	<b>Coupled with...</b>	<b>Connects to...</b>
<b>LI-210R-BNC</b>	<b>2290 mV Adapter</b> (0 to 10 mV output)	Devices that read a voltage signal with good resolution (in the $\mu$ V range)
<b>LI-210R-SMV</b>	Includes a standardized mV adapter with 10 mV output at full scale (part number 2321)	
<b>LI-210R-BL</b>	Precision resistor	
<b>LI-210R-BNC</b>	<b>2420-BNC Amplifier</b> (-2.5 to 5.0 V output)	Devices that read a voltage signal
<b>LI-210R-BL</b>	<b>2420-BL Amplifier</b> (-2.5 to 5.0 V output)	

## Section 2.

# Using the LI-210R Photometric Sensor

## Mounting

The LI-210R Photometric Sensor may be hand-held or mounted to an instrument platform. For best results, install your sensor in the 2003S Mounting and Leveling Fixture. Secure the sensor in the fixture by tightening the mounting screws against the sensor base. Level the fixture with the bubble by adjusting the three leveling screws. The 2003S Mounting and Leveling Fixture can be secured to a structure with bolts or screws placed through the three holes in the fixture.

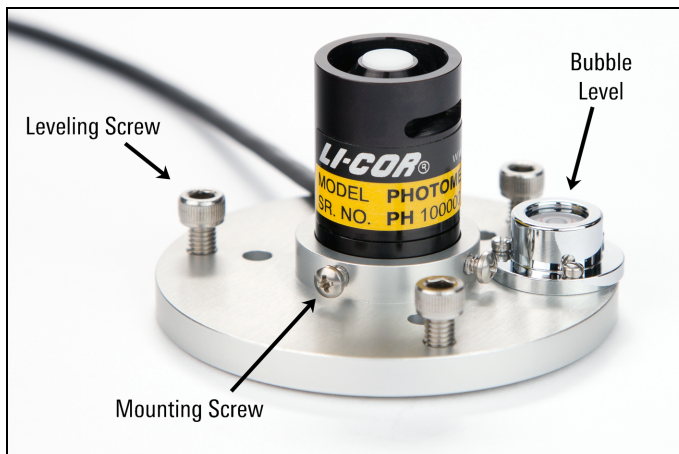

Figure 2-1. LI-210R Photometric Sensor mounted in the 2003S Mounting and Leveling Fixture.

Secure cables to the instrument platform using cable ties. Be sure there is no strain on the junction where the cable enters the sensor housing, and use a cable tie at any sharp bends in the cable.

## Calibration Constants and Multipliers

Each LI-COR radiation sensor is shipped with a certificate of calibration. The certificate is also available at [www.licor.com/env/support/](http://www.licor.com/env/support/). Enter the sensor's serial number in the calibration search box. The calibration constant and multipliers are listed on the certificate in the following order:

- 1. Calibration constant.** The current signal produced by a photometric sensor is related to radiation intensity with a calibration constant unique to each sensor, expressed in units of  $\mu\text{A}$  per 100 klux. The calibration constant is used to compute calibration multipliers.
- 2. Multiplier for use with LI-COR handheld meters and loggers.** LI-COR handheld meters and loggers convert the current ( $\mu\text{A}$ ) signal into units of radiation (klux) by applying this multiplier, expressed in radiation units per current ( $\text{klux } \mu\text{A}^{-1}$ ). This multiplier is a negative number.
- 3. Multiplier for use with LI-210R-BL (3-wire bare leads).** This multiplier is expressed in radiation units per current ( $\text{klux } \mu\text{A}^{-1}$ ) and is a positive number.
- 4. Multiplier for use with LI-COR 2290 (604  $\Omega$ ) Millivolt Adapter.** This multiplier is expressed in radiation units per voltage ( $\text{klux } \text{mV}^{-1}$ ) and is a negative number.
- 5. Multiplier for use with the SMV Photometric Sensor.** The final multiplier listed is  $-10.0 \text{ klux } \text{mV}^{-1}$ . The multiplier is the same for any LI-210R-SMV Photometric Sensor because the resistance of the included standard output millivolt adapter (part number 2321) is adjusted to each sensor's current output (see page 3-2). The LI-210R-SMV replaces the LI-210SL and uses the same millivolt adapter and multiplier.



## Using the LI-210R-BNC Photometric Sensor

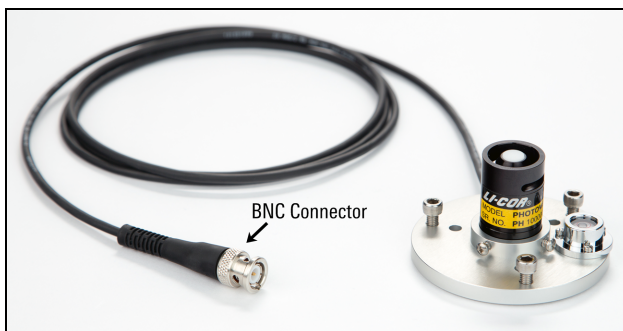

Figure 2-2. LI-210R-BNC Photometric Sensor.

Connect the BNC-type cable directly to a BNC input port on an LI-250A Light Meter, LI-1400 Datalogger, or LI-1500 Light Sensor Logger. These devices directly measure the current ( $\mu\text{A}$ ) signal from the sensor. Enter the sensor's multiplier (see "Multiplier for use with LI-COR handheld meters and loggers" on the previous page) into the device to determine visible light expressed in units of klux.

### LI-1500 Light Sensor Logger



## Using the LI-210R-BL Photometric Sensor

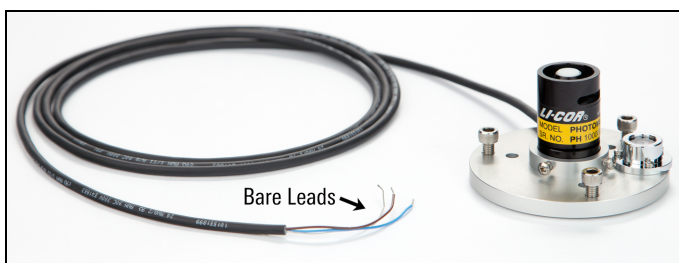
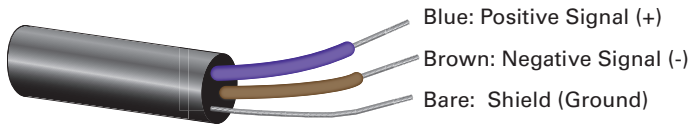

Figure 2-3. LI-210R-BL Photometric Sensor featuring 3-wire bare leads.

A BL-type sensor cable terminates with bare wire leads. Connect the bare leads to the input terminal block of a device that directly measures a current ( $\mu\text{A}$ ) signal. The blue wire carries a positive signal and the brown wire is negative. Connecting the bare (shield) wire to ground will reduce noise in the sensor signal.



To log radiation units (klux), configure the recording device to multiply the  $\mu\text{A}$  signal by the sensor's multiplier (see "Multiplier for use with the LI-210R-BL" on page 2-2) prior to logging the values. If logging the  $\mu\text{A}$  sensor signal, apply the multiplier after logging.

The LI-210R-BL can be used with recording devices that require a voltage (mV) signal by adding a precision resistor (see "Voltage Signal Options" below).

## Voltage Signal Options

If the meter or logging device requires a voltage signal, options include:

- **LI-210R-BNC coupled with a 2290 Millivolt Adapter.** The 2290 Millivolt Adapter converts the current ( $\mu\text{A}$ ) signal from the sensor into a millivolt-level voltage (see page 3-1).
- **LI-210R-SMV Photometric Sensor.** The LI-210R-SMV includes a Standardized Millivolt Adapter (part number 2321) matched to a particular sensor. The serial numbers on the adapter and the sensor must match! The advantage over the 2290 Millivolt Adapter is that the multiplier in your device does not need to be changed for different sensors (see page 3-2).
- **LI-210R coupled with a 2420 Light Sensor Amplifier.** The 2420 Amplifier converts the current ( $\mu\text{A}$ ) signal from the sensor into a voltage (see page 4-1).
- **LI-210R-BL coupled with a precision resistor.** Connect the resistor across the positive and negative leads of the cable. The recommended resistance is  $604 \Omega$ , with a maximum output of approximately 10 mV per 100 klux. See "2290 Millivolt Adapter" on page 3-1 for instructions on calculating the multiplier, but use the absolute value of the multiplier.

With a Millivolt Adapter or other resistor, the signal to noise ratio (sensitivity) is lower than with the 2420 Light Sensor Amplifier, but the cost is less and there is no need for a power supply to the adapter.

**Caution:** Do not attach the sensor to a power source. The sensor is self-powered.

## Section 3.

# Millivolt Adapters

---

LI-COR radiation sensors produce a current ( $\mu\text{A}$ ) output signal that can be converted to a voltage through the use of a resistor. LI-COR makes two types of millivolt adapters for use with our BNC-type radiation sensors. Each adapter includes a precision resistor and a BNC connector that mates with the sensor. Bare leads can be connected to a data logger or other device that reads a voltage signal.

The maximum output of LI-COR radiation sensors in typical conditions is relatively small (microamps of current) and converts into a small voltage. To monitor these sensors with expected accuracy, a data logger needs to have the ability to measure in the microvolt range. To increase sensitivity, make sure the voltage range of the channel is set as close as possible to the full-scale range of the sensor. For example, 0 to 25 mV should cover the range of values expected in a natural sunlight environment.

If the data logger does not have the ability to measure microvolt signals or the ability to set channel voltage ranges down to a 0–25 mV level, another option should be considered, such as the 2420 Light Sensor Amplifier.

### 2290 Millivolt Adapter

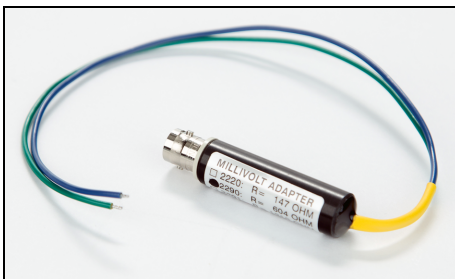

An LI-210R Photometric Sensor with a BNC-type cable can be used with a millivolt recorder or data logger by connecting a model 2290 Millivolt Adapter. Convert the voltage measured by the data logger into radiation units (klux) by applying the appropriate multiplier, given on the sensor's certificate of calibration (see "Multiplier for use with LI-COR 2290" on page 2-2).

The multiplier  $M$  for use with a millivolt adapter can also be found by:

$$M = \frac{-1}{G \cdot C}$$

The 2290 Millivolt Adapter includes a precision resistor with a fixed resistance of  $604 \Omega$ , tolerance of  $\pm 0.1\%$ , and a fixed gain of  $G = 0.604 \text{ mV } \mu\text{A}^{-1}$ . The sensor's calibration constant  $C$  is found on the certificate of calibration (see "Calibration constant" on page 2-2). The calculated multiplier will be a negative number (because the shield of the coaxial cable of the sensor carries the positive signal) and is expressed in units of  $\text{klux mV}^{-1}$ .

**Example:** Calculate  $M$  using  $G = 0.604 \text{ mV } \mu\text{A}^{-1}$  and  $C = 30.56 \mu\text{A}$  per 100 klux.

$$M = \frac{-1}{\left(0.604 \frac{\text{mV}}{\mu\text{A}}\right) \left(\frac{30.56 \mu\text{A}}{100 \text{ klux}}\right)} = -5.42 \text{ klux mV}^{-1}$$

## Connecting the 2290 Millivolt Adapter

If the data logger or recorder being used with this millivolt adapter has bipolar capability, connect the positive (green) lead to the common (low) terminal, and connect the negative (blue) lead to signal (high) input. This will help minimize noise.

If the data logger has high, low, and ground terminals, place a jumper wire between the common (low) and ground terminals.

If bipolar signal capability is not available, connect the positive (green) lead to the signal input, and the negative (blue) lead to the common terminal. In this case, use the absolute value of the multiplier.

## LI-210R-SMV Photometric Sensor

The LI-210R-SMV Photometric Sensor includes a Standard Output Millivolt Adapter (part number 2321) terminating in bare leads. The serial number on

the sensor head must match the serial number on the adapter because the resistance is adjusted to each sensor's current output. This allows a standardized output of 10 mV per 100 klux. The multiplier used to convert the voltage measured by the data logger into a light intensity is  $-10.0 \text{ klux mV}^{-1}$  (also listed on the sensor's certificate of calibration).

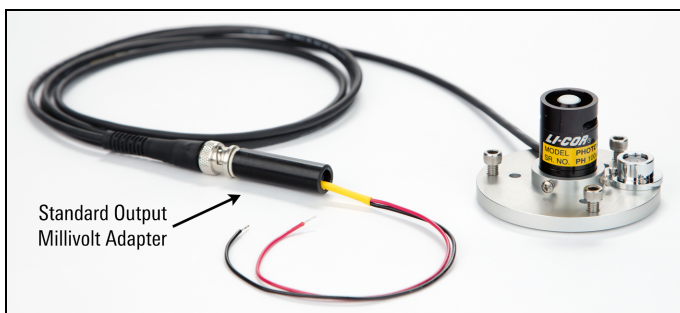

Figure 3-1. LI-210R-SMV Photometric Sensor.

The advantage of using an LI-210R-SMV (compared to an LI-210R-BNC with a 2290 Millivolt Adapter) is that sensors can be exchanged in the field without the need to change the multiplier in the data logger or recorder.

An LI-210R Photometric Sensor with a BNC-type connector can be converted to an LI-210R-SMV by attaching a Standard Output Millivolt Adapter (part number 2321) to the BNC connector. The 2321 adapter must be matched to the individual sensor. LI-COR needs the sensor's serial number in order to adjust an adapter to match the sensor.

### **Connecting the LI-210R-SMV Photometric Sensor**

If your data logger or recorder has bipolar signal capability, connect the positive (red) lead to the common (low) terminal, and connect the negative (black) lead to signal (high) input. This will help minimize noise in the signal.

If the data logger has high, low, and ground terminals, place a jumper wire between the common (low) and ground terminals.

If bipolar signal capability is not available, connect the positive (red) lead to the signal input, and the negative (black) lead to the common terminal. In this case, use the absolute value of the multiplier.



## Section 4.

# 2420 Light Sensor Amplifier

The 2420 Light Sensor Amplifier converts the current ( $\mu\text{A}$ ) signal from the radiation sensor into a voltage that can be measured by most data loggers and system controllers. The 2420 Amplifier works with both old and new LI-COR radiation sensor designs. Two amplifier models are available:

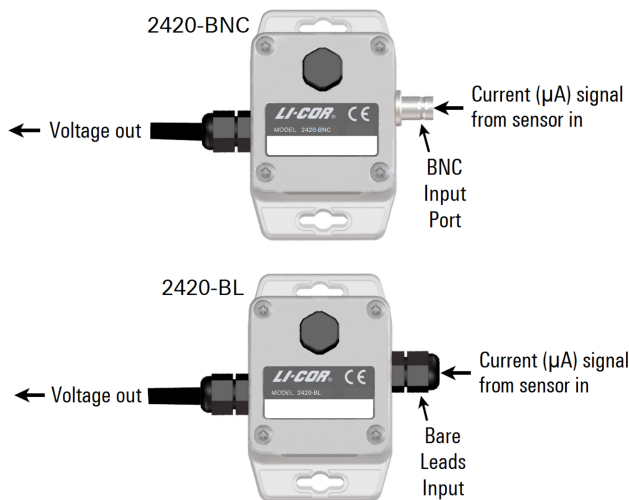

**Note:** The 2420 Amplifier is weather resistant **with the lid properly attached**, but if it is to be left outdoors for long periods of time, it should be installed in a protective enclosure or sheltered location.

## 2420 Amplifier Gain Settings

The 2420 Amplifier provides 15 discrete gain settings to accommodate a variety of full-scale light intensities, full-scale voltage ranges, and sensor types. This

section shows how to determine the correct gain settings and multiplier. Gather the following information:

- Calibration constant for your light sensor ( $C$ )
- Maximum full-scale radiation intensity to be measured ( $I_{max}$ )
- Full-scale input voltage of the datalogger ( $V_{max}$ )

Follow these steps to calculate the amplifier gain setting and voltage multiplier:

1. Calculate the ideal amplifier gain ( $G_{ideal}$ ).

$$G_{ideal} = \frac{V_{max}}{I_{max} \cdot C}$$

**Example:** Consider a quantum sensor with the following parameters:

- Sensor calibration constant:  $C = 30.65 \mu\text{A}$  per 100 klux
- Full-scale light intensity:  $I_{max} = 200 \text{ klux}$
- Datalogger full-scale channel voltage:  $V_{max} = 5.0 \text{ V}$

$$G_{ideal} = \frac{5.0\text{V}}{\left(200 \text{ klux}\right) \left(\frac{30.65 \mu\text{A}}{100 \text{ klux}}\right)} = 0.0816 \text{ V } \mu\text{A}^{-1}$$

2. Select the gain setting ( $G$ ) from Table 4-1 that is less than or equal to the ideal gain from step 1.

**Example:** The ideal gain computed in step 1 is  $G_{ideal} = 0.0816 \text{ V } \mu\text{A}^{-1}$ . On the table, the closest actual gain that is less than or equal to this value is  $G = 0.075 \text{ V } \mu\text{A}^{-1}$ .

3. Use a number 2 Phillips screwdriver to remove the amplifier lid. Alternate the four screws, pulling the lid up with the screws as you go so that the screws do not bind with the lid.
4. Using a small screwdriver, set the four switches in the center of the circuit board based on the amplifier gain determined in step 2.

**Example:** The amplifier gain determined in step 2 ( $G = 0.075 \text{ V } \mu\text{A}^{-1}$ ) requires the number 1 and 2 switches to be in "off" position, and the number 3 and 4 switches to be in the "on" position:

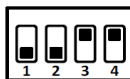



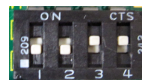





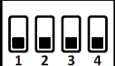

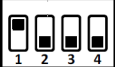
$G = 0.075$



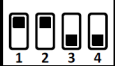
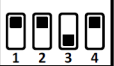
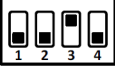

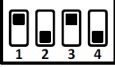
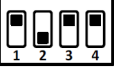
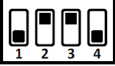
**Table 4-1.** Gain settings table for the 2420 Amplifier

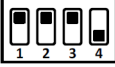
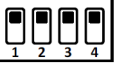
<b>2420 Gain Settings Table</b>			
<b>DIP Switch</b>	<b>Gain (<math>V \mu A^{-1}</math>)</b>	<b>DIP Switch</b>	<b>Gain (<math>V \mu A^{-1}</math>)</b>
	G = 0.375 (all switches off)		G = 0.175
	G = 0.350		G = 0.150
	G = 0.325		G = 0.125
	G = 0.300		G = 0.100
	G = 0.275		G = 0.075
	G = 0.250		G = 0.050
	G = 0.225		G = 0.025
	G = 0.200		Do Not Use (all switches on)

5. Re-install the lid. Torque the screws to 0.45 Nm (64 oz-in.) if using a torque screwdriver.

6. Calculate the voltage multiplier ( $M$ ). The voltage multiplier is used to convert the voltage measured by the data logger into units of radiation (klux). The units for  $M$  are klux  $V^{-1}$ .

$$M = \frac{1}{G \cdot C}$$

**Example:** Calculate  $M$  using  $G = 0.075 \text{ V } \mu\text{A}^{-1}$  from step 2 and  $C = 30.65 \text{ } \mu\text{A}$  per 100 klux from step 1:

$$M = \frac{1}{\left(0.075 \frac{\text{V}}{\mu\text{A}}\right) \left(\frac{30.65 \mu\text{A}}{100 \text{ klux}}\right)} = 43.72 \text{ klux } V^{-1}$$

## Connecting to a Data Logger

**Note:** The 2420 Amplifier requires a power supply (white wire, +3.8 to 28 VDC), usually from the datalogger. The datalogger should wait a minimum of 0.12 seconds (120 ms) after providing power before reading the output voltage from the amplifier.

### Amplifier Output Terminal Block Wiring

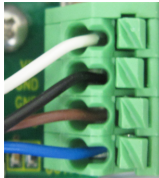

White: +3.8 to 28V power supply input

Black: Power supply ground ( $\neq$ )

Brown: Negative (-) amplifier output

Blue: Positive (+) amplifier output

The 2420-BNC and 2420-BL Amplifier output wires (included) can be connected to a datalogger in both differential and single-ended configurations, as shown in the following diagrams. The differential configuration can give better noise rejection and lower offset voltages.

**Note:** Avoid extending the output wire length. The amplifier and data logger should be kept close together to avoid excess voltage drop and the introduction of noise.

### Data logger Wiring, Differential

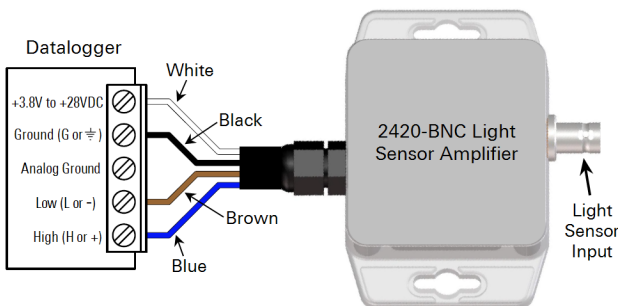

### Data logger Wiring, Single-ended

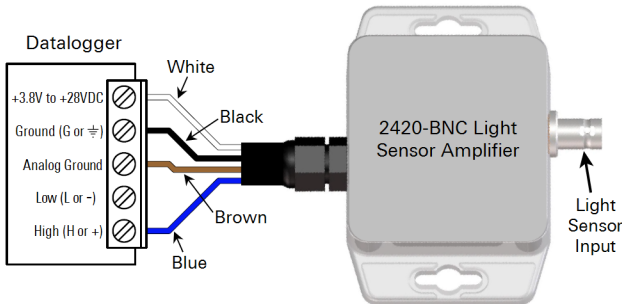

**Important Note!** In the single-ended configuration, use the following steps to check for ground loops. *This procedure only applies when the 2420 is in the single-ended configuration.*

1. Disconnect the light sensor from the amplifier.
2. Using a multiplier of 1 and an offset of 0 in the datalogger program, monitor the "dark offset" mV measurement from the amplifier.
3. If the dark offset is  $> 1$  mV, try disconnecting either the brown or black lead (but not both) to minimize the offset.
4. If the offset is minimized by removing either the brown or black wire, then move this wire off to the side and insulate it with a piece of electrical tape.
5. Reconnect the light sensor to the amplifier and reset the multiplier and offset in the data logger program.

## Connecting to a Sensor

**Note:** The 2420 Amplifier requires a current ( $\mu\text{A}$ ) signal from the sensor. It will not work with a millivolt adapter or with a sensor that produces a voltage signal output.

LI-COR radiation sensors come wired with bare leads or a BNC connector.

**2420-BNC Light Sensor Amplifier:** connects to a BNC type light sensor. Attach the BNC connector to the BNC input port on the Amplifier.

**2420-BL Light Sensor Amplifier:** connects to a bare lead type sensor with these steps:

1. Use a number 2 Phillips screwdriver to remove the amplifier lid. Alternate the four screws, moving the lid up with the screws so that the screws do not bind with the lid.
2. Loosen (but do not remove) the black plastic nut on the input port.
3. Feed the sensor cable through the nut and input port far enough that the black shielded portion extends inside the amplifier, then hand tighten the nut.
4. Press down on the connector's spring release and insert the sensor wires into the terminal block as shown below.

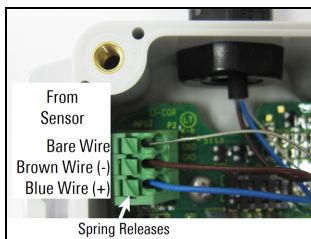
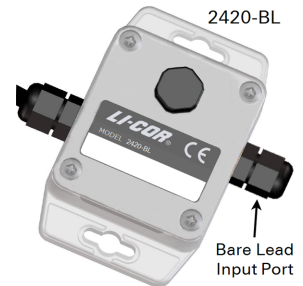
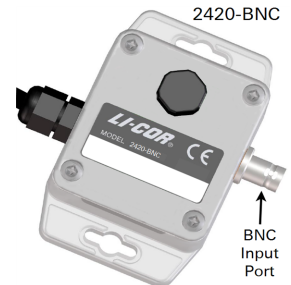

5. Re-install the lid. Torque the screws to 0.45 Nm (64 oz-in.) if using a torque screwdriver.

## Equation Summary

### Output Voltage

The 2420 Light Sensor Amplifier output voltage is computed as:

$$V_{out} = G \cdot i$$

Variable	Units	Description
$V_{out}$	V	Amplifier output voltage
$G$	$V \mu A^{-1}$	Amplifier gain setting
$i$	$\mu A$	Light sensor photocurrent signal

### Ideal Gain

The ideal gain ( $G_{ideal}$ ) is the gain needed by the 2420 Amplifier to adjust the full-scale sensor output to the full-scale input voltage of the data logger. The 2420 Amplifier uses 15 discrete gain settings, so the ideal gain must be rounded **down** to the nearest supported gain. Ideal gain is computed as:

$$G_{ideal} = \frac{V_{max}}{I_{max} \cdot C}$$

Variable	Units	Description
$G_{ideal}$	$V \mu A^{-1}$	Ideal amplifier gain
$V_{max}$	V	Data logger full-scale input voltage
$I_{max}$	klux	Photometric sensor full-scale light
$C$	$\mu A$ per 100 klux	Photometric sensor calibration coefficient

### Voltage Multiplier

The voltage multiplier  $M$  converts the voltage measured by the data logger into a light intensity. The multiplier is found by:

$$M = \frac{1}{G \cdot C}$$

Variable	Units	Description
$M$	$klux V^{-1}$	Photometric sensor voltage multiplier
$G$	$V \mu A^{-1}$	Amplifier gain setting
$C$	$\mu A$ per 100 klux	Photometric sensor calibration coefficient

## 2420 Amplifier Performance Characteristics

### Output

The 2420 Amplifier generates an output signal up to 5.0 V and down to -2.5 V over the entire input supply voltage range (+ 3.8 to 28 VDC). The output is linear with the current signal provided by the light sensor with an offset of  $\pm < 10 \mu\text{V}$ , meaning that 0  $\mu\text{A}$  of input current yields a 0 V  $\pm < 10 \mu\text{V}$  output voltage.

**Note:** The 2420 Amplifier is capable of driving a resistive load of 10 k $\Omega$  or greater. Most datalogger voltage inputs have an input impedance (resistance) much higher than 10 k $\Omega$ , satisfying the output loading requirements of the 2420. Loading the output with a resistance less than 10 k $\Omega$  may cause erroneous readings.

### 2420 Amplifier Specifications

<b>2420 Light Sensor Amplifier Specifications</b>	
Power Requirements:	+3.8 to 28 V (1 mA over full range)
Operating Temperature Range:	-40 °C to 50 °C
Turn-on Time:	120 ms
Amplifier Output:	-2.5 to 5.0 V
Output Offset Voltage:	-10 to 10 $\mu\text{V}$
Amplifier Gain Range:	0.025 to 0.375 V $\mu\text{A}^{-1}$
Amplifier Gain Accuracy:	$\pm 0.1\%$ typical ( $\pm 0.15\%$ max) of gain setting
Amplifier Output Noise:	0.5 $\mu\text{V}$ rms (0.375 V $\mu\text{A}^{-1}$ Gain, 0.1 to 10 Hz Bandwidth)
Amplifier Output Loading:	$\geq 10 \text{ k}\Omega$

# Section 5.

## Performance Characteristics

---

### Cosine Response

The amount of radiation incident on a given flat (not necessarily level) surface area varies with the angle of incidence. Lambert's cosine law says that the radiant intensity observed from an ideal diffusely reflecting surface is directly proportional to the cosine of the angle of incidence.

When radiation strikes a given surface area at a greater angle of incidence, less radiation is received on that surface (see Figure 5-2). For instance, when radiation strikes a given unit area at a  $60^\circ$  angle of incidence, half as much is received compared to a  $0^\circ$  angle of incidence. The same amount of radiation is spread over more surface area at a  $60^\circ$  angle of incidence.

### LI-210R Cosine Correction

A cosine-corrected sensor follows Lambert's cosine law and provides the most accurate measurements of radiation on a flat surface from all angles. Cosine correction ensures accurate measurements under various conditions such as low light levels and low solar elevation angles.

The LI-210R is fully cosine-corrected, with sensitivity to light nearly equal at all angles of incidence to about  $82^\circ$  angle of incidence (Figure 5-1). Errors are typically less than  $\pm 5\%$  for angles less than  $82^\circ$  from the normal axis. At  $90^\circ$ , a perfect cosine response would be zero, and any error at that angle is infinite.

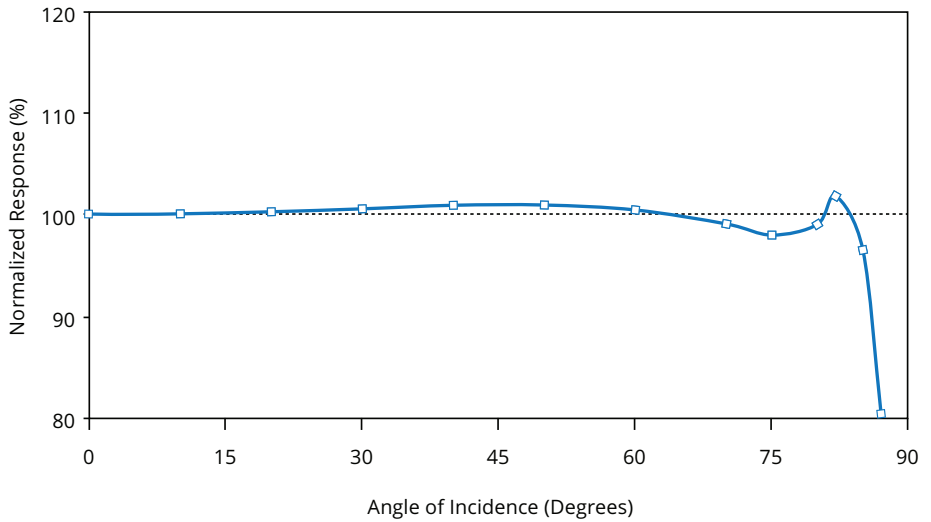

Figure 5-1. Typical cosine response of the LI-210R Photometric Sensor.

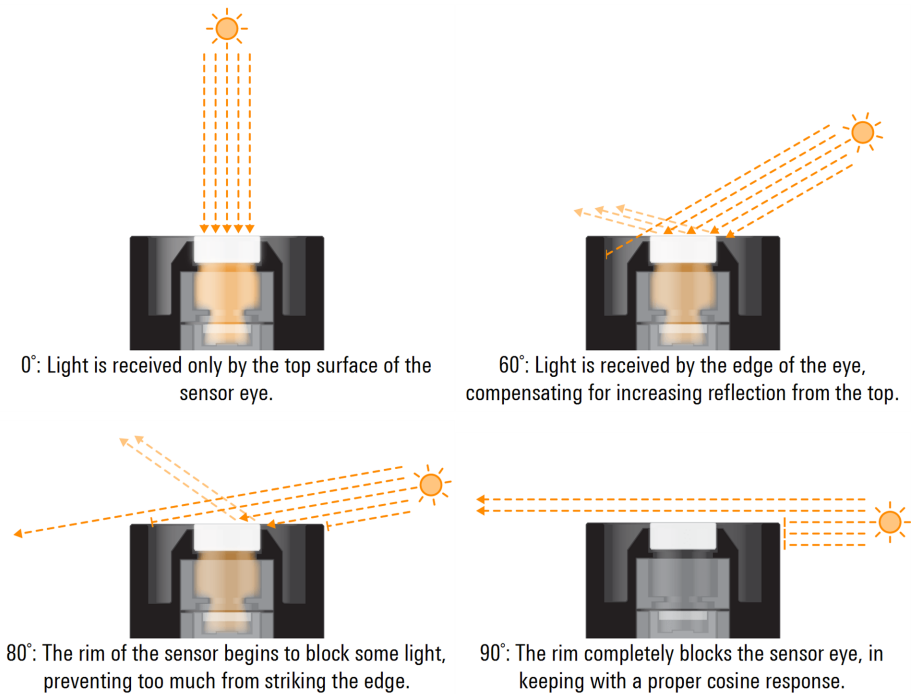

Figure 5-2. LI-COR sensor creating the proper cosine response at various angles of incidence.



Figure 5-2 shows how the design of the sensor creates the proper cosine response. Radiation is received by an acrylic disc called a diffuser, or eye. When radiation strikes with a greater angle of incidence, more is received by the edge of the eye. This compensates for increasing reflection from top surface as the angle of incidence grows larger. Beyond an angle of about 80°, the rim of the sensor begins to block some light in order to maintain the correct response as more radiation is received by the edge of the eye. At a 90° angle of incidence, the rim completely blocks the eye, in keeping with a proper cosine response.

## Spectral Response

The spectral response of a typical LI-210R Photometric Sensor corresponds closely to the C.I.E. standard observer curve. LI-COR has had sensor calibration data verified by the National Research Council of Canada (NRC), one of the major standards laboratories in the world.

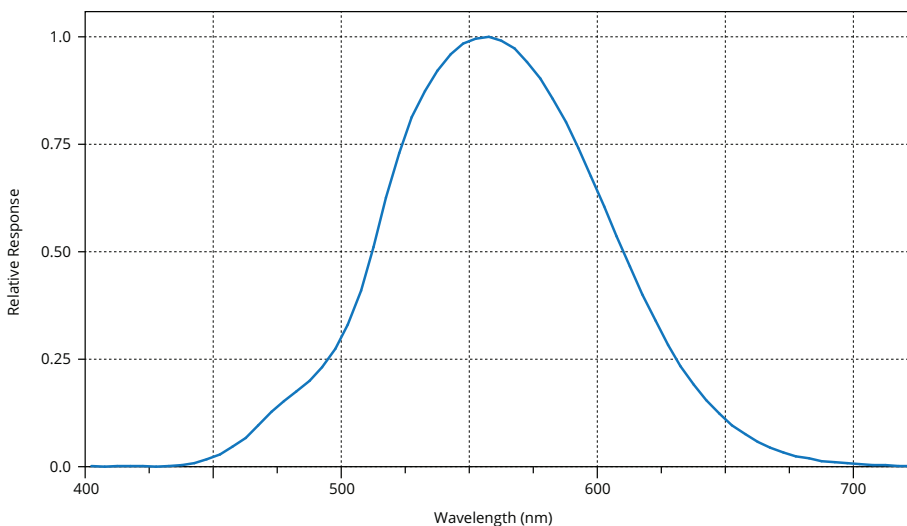

Figure 5-3. Typical spectral response of the LI-210R Photometric Sensor.

## Calibration

Each LI-COR radiation sensor is fully calibrated at the factory, and no user calibration is needed. Acquire the calibration for your sensor by entering the serial number at [www.licor.com/env/support/](http://www.licor.com/env/support/). The recommended

recalibration interval is every 2 years. Return your sensor to LI-COR for recalibration (see "Factory Recalibration" on page 6-2).

Each LI-210R Photometric Sensor is calibrated against a standard lamp using 683 lumens per watt as the value of spectral luminous efficacy at a wavelength of 555 nm. This value conforms to the recommendations of the International Committee for Weights and Measures (CIPM). The uncertainty of calibration is  $\pm 5\%$ , traceable to the U.S. National Institute of Standards and Technology (NIST).

# Section 6.

## Care and Maintenance

---

For best performance and longevity, treat the sensor carefully. The protective cap that came with the sensor can be used later when shipping the sensor for factory re-calibration.

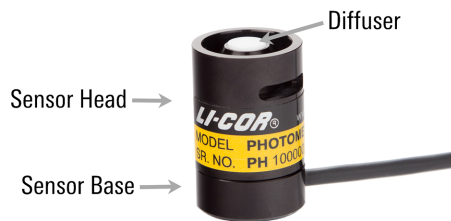

Figure 6-1. LI-210R Photometric Sensor

The vertical edge of the acrylic diffuser (see Figure 6-1) must be clean to maintain calibration and correct cosine response. Use warm water and a soft, lint-free towel or cotton-tipped swab to remove dust and other soluble deposits. If needed, use a mild detergent to clean the sensor. Use a solution of vinegar and water for stubborn hard water deposits or salt buildup.

**Important Note!** Refrain from applying pressure to the diffuser when cleaning the sensor. Scratches on the surface of the diffuser will degrade the cosine performance of the sensor.

The sensor head may be disconnected from the sensor base (see page 6-2), but do not attempt to disassemble the sensor head. Doing so will alter the sensor's calibration, void the sensor's warranty, and potentially provide entry points for water, which will damage the sensor.

## Factory Recalibration

Each sensor is fully calibrated at the factory. The recommended recalibration interval is every 2 years.

**Note:** A sensor's certificate of calibration indicates the last date of calibration. You can acquire the certificate of calibration for your sensor by entering the sensor serial number at [www.licor.com/env/support/](http://www.licor.com/env/support/).

Return your sensor to LI-COR for recalibration. If possible, replace the protective cap that came with the sensor. Ship the sensor head attached to the base and cable assembly when possible. For tower installations, solar arrays, or other cases where it would be better to leave the cable behind, the sensor head may be removed from the base and cable assembly for shipment (see "Removing a Cable" below).

For uninterrupted data collection, you have the option of purchasing sensor heads without cables. These calibrated sensor heads can be used as spares.

## Removing a Cable

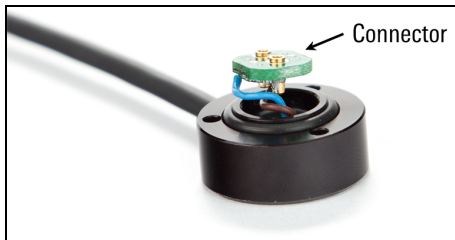

Figure 6-2. Sensor base and cable assembly with sensor head removed.

1. Remove the sensor from the mounting and leveling fixture to gain access to the machine screws on the bottom of the sensor base.
2. Remove the three screws from the bottom of the sensor base with a number 1 Phillips screwdriver.
3. Pull the sensor head away from the base until the two-pin female connector separates from the base pins. Pull the two components straight apart without twisting.
4. If the sensor base will be left exposed, install a Sensor Base Cover (see page 6-3).

Any cable can be used with any sensor head without altering the calibration. Cables are interchangeable between the LI-190R, LI-200R, and LI-210R sensors.

## Sensor Base Cover

When a sensor base must be left behind while the head is being factory recalibrated, protect it by attaching a 2001S Sensor Base Cover, available from LI-COR. Attach using the same screws that held the sensor head to the base.



Figure 6-3. Sensor Base Cover installed on the sensor base in place of the sensor head.

## Installing a Cable

1. Place the protective cap (shipped with the sensor) on the sensor head or use another method to protect the acrylic diffuser on top of the sensor head.
2. Turn the sensor head upside down and check the pins to ensure they are not bent. Inspect the o-ring in the base and replace if it is damaged.
3. Press the female connector firmly onto the pins of the light sensor head using your finger or a small flat-blade screwdriver. The two-pin connector is polarized so that it can only be attached in one orientation.

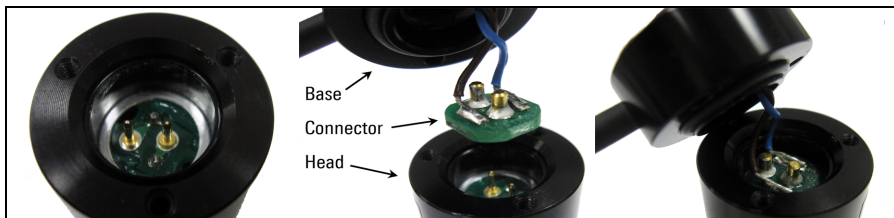

4. Orient the light sensor and base so the mounting holes align and insert the three machine screws through the light sensor base and into the sensor head.
5. Tighten the screws with a number 1 Phillips screwdriver. If you are using a torque screwdriver, tighten the screws to 0.41 Nm (58 oz-in).

## Replacement Parts

- 210R: Calibrated Photometric Sensor Head

Base and Cable Assemblies:

- BNC-2: 2-meter cable with BNC terminal
- BNC-5: 5-meter cable with BNC terminal
- BNC-15: 15-meter cable with BNC terminal
- BNC-50: 50-meter cable with BNC terminal
- BL-2: 2-meter cable with bare leads
- BL-5: 5-meter cable with bare leads
- BL-15: 15-meter cable with bare leads
- BL-50: 50-meter cable with bare leads



Photometric Sensor Head

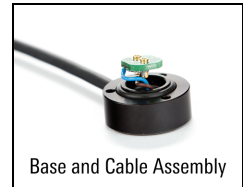

Base and Cable Assembly

Replace a damaged base and cable assembly or change the terminal type and / or cable length of a sensor by purchasing a new base and cable assembly from LI-COR and installing it onto the sensor head.

Calibrated LI-190R, LI-200R, or LI-210R sensor heads (without cables) are available for purchase from LI-COR. Sensor heads can replace damaged heads, or be used as spares.

Any base and cable assembly can be used interchangeably with any LI-190R, LI-200R, or LI-210R sensor head.



Sensor Heads

- **Flat head Phillips machine screw**, 2-56 threads, 1/2" long, 82° countersink, stainless steel (for securing the sensor base to the sensor head), LI-COR part number 122-12774. Three screws are required for each sensor.
- **O-ring AS-014 Viton75** (for the sensor base), LI-COR part number 192-14878.

# Section 7.

## Troubleshooting

---

### Sensor readings have a negative (-) sign:

- Check for proper wiring of the LI-210R-BL (see page 2-3), 2220 Millivolt Adapter (see page 3-2), or LI-210R-SMV (see page 3-3).
- Make sure the proper sign was used on the multiplier entered into the LI-1500, LI-1400, or LI-250A, or other recording device (see "Calibration Constants and Multipliers" on page 2-2).

### Sensor readings are incorrect:

- Make sure the meter or logger is properly configured, including entering the sensor's correct calibration multiplier. Note that multipliers are different from the calibration constant, and there are different multipliers for use with millivolt adapters (see "Calibration Constants and Multipliers" on page 2-2).
- Check the sensor's last calibration. Certificates of calibration are available at: [www.licor.com/env/support/](http://www.licor.com/env/support/). Enter the sensor's serial number in the calibration data search box. Certificates include multipliers and the sensor's last calibration date. LI-COR recommends factory recalibration for radiation sensors every two years ("Calibration Constants and Multipliers" on page 2-2).
- Check for loose cable connections. Moisture on connections can also cause erroneous readings.
- Check the sensor cable for damage, including nicks, cuts, or sharp bends.
- Contact LI-COR technical support ([envsupport@licor.com](mailto:envsupport@licor.com)) if you are unable to resolve the issue.





# Appendix A.

## Specifications

---

### LI-210R Photometric Sensor Specifications

**Absolute Calibration:**  $\pm 5\%$  traceable to the U.S. National Institute of Standards and Technology (NIST).

**Sensitivity:** Typically 30  $\mu\text{A}$  per 100 klux.

**Linearity:** Maximum deviation of 1% up to 100 klux.

**Response Time:** Less than 1  $\mu\text{s}$  (2 m cable terminated into a 604  $\Omega$  load).

**Temperature Dependence:**  $\pm 0.15\%$  per  $^{\circ}\text{C}$  maximum.

**Cosine Correction:** Cosine corrected up to  $82^{\circ}$  angle of incidence.

**Azimuth:**  $< \pm 1\%$  error over  $360^{\circ}$  at  $45^{\circ}$  elevation.

**Tilt:** No error induced from orientation.

**Detector:** High stability silicon photovoltaic detector (blue enhanced).

**Sensor Housing:** Weatherproof anodized aluminum case with acrylic diffuser and stainless steel hardware; O-ring seal on the removable base and cable assembly.

**Size:** 2.36 cm Diameter x 3.63 cm (0.93" x 1.43").

**Weight:** 24 g head; 60 g base and cable assembly (2 m) with screws.

**Cable Length:** 2 m, 5 m, 15 m, 50 m (6.5', 16.4', 49.2', 164').



# Appendix B.

## Warranty

---

Each LI-COR, Inc. instrument is warranted by LI-COR, Inc. to be free from defects in material and workmanship; however, LI-COR, Inc.'s sole obligation under this warranty shall be to repair or replace any part of the instrument which LI-COR, Inc.'s examination discloses to have been defective in material or workmanship without charge and only under the following conditions, which are:

- 1.** The defects are called to the attention of LI-COR, Inc. in Lincoln, Nebraska, in writing within one year after the shipping date of the instrument.
- 2.** The instrument has not been maintained, repaired or altered by anyone who was not approved by LI-COR, Inc.
- 3.** The instrument was used in the normal, proper and ordinary manner and has not been abused, altered, misused, neglected, involved in an accident or damaged by act of God or other casualty.
- 4.** The purchaser, whether it is a DISTRIBUTOR or direct customer of LI-COR or a DISTRIBUTOR'S customer, packs and ships or delivers the instrument to LI-COR, Inc. at LI-COR Inc.'s factory in Lincoln, Nebraska, U.S.A. within 30 days after LI-COR, Inc. has received written notice of the defect. Unless other arrangements have been made in writing, transportation to LI-COR, Inc. (by air unless otherwise authorized by LI-COR, Inc.) is at customer expense.
- 5.** No-charge repair parts may be sent at LI-COR, Inc.'s sole discretion to the purchaser for installation by purchaser.
- 6.** LI-COR, Inc.'s liability is limited to repair or replace any part of the instrument without charge if LI-COR, Inc.'s examination disclosed that part to have been defective in material or workmanship.

**There are no warranties, express or implied, including but not limited to any implied warranty of merchantability of fitness for a particular purpose on underwater cables or on expendables such as batteries, lamps, thermocouples, and calibrations.**

**Other than the obligation of LI-COR, Inc. expressly set forth herein, LI-COR, Inc. disclaims all warranties of merchantability or fitness for a particular purpose. The foregoing constitutes LI-COR, Inc.'s sole obligation and liability with respect to damages resulting from the use or performance of the instrument and in no event shall LI-COR, Inc. or its representatives be liable for damages beyond the price paid for the instrument, or for direct, incidental or consequential damages.**

The laws of some locations may not allow the exclusion or limitation on implied warranties or on incidental or consequential damages, so the limitations herein may not apply directly. This warranty gives you specific legal rights, and you may already have other rights which vary from state to state. All warranties that apply, whether included by this contract or by law, are limited to the time period of this warranty which is a twelve-month period commencing from the date the instrument is shipped to a user who is a customer or eighteen months from the date of shipment to LI-COR, Inc.'s authorized distributor, whichever is earlier.

This warranty supersedes all warranties for products purchased prior to June 1, 1984, unless this warranty is later superseded. To the extent not superseded by the terms of any extended warranty, the terms and conditions of LI-COR's Warranty still apply.

DISTRIBUTOR or the DISTRIBUTOR's customers may ship the instruments directly to LI-COR if they are unable to repair the instrument themselves even though the DISTRIBUTOR has been approved for making such repairs and has agreed with the customer to make such repairs as covered by this limited warranty.

Further information concerning this warranty may be obtained by writing or telephoning Warranty manager at LI-COR, Inc.

# Index

---

## 2

- 2001S Sensor Base Cover 6-3
- 2003S Mounting and Leveling Fixture 2-1
- 2290 Millivolt Adapter 3-2
- 2321 Standard Output Millivolt Adapter 3-2
- 2420 Light Sensor Amplifier 4-1
  - performance characteristics 4-8
  - specifications 4-8

## A

- Accessories 1-3
- Amplifier 4-1

## B

- Bare Leads 1-2, 2-4
- Base and Cable Assembly 1-2
  - installing 6-3, 6-3
  - removing 6-3
- Base Cover 6-3
- BNC connector 1-2

## C

- Cable Terminals 1-2
- Cables 1-2
  - installing 6-3, 6-3
  - removing 6-3
  - securing 2-2
- Calibration 5-3
  - certificate 2-2
  - constants 2-2

factory 5-3

multipliers 2-2, 2-4

Certificate of Calibration 2-2

Cleaning 6-1

Comparing Sensors 1-1

Configurations

for a current signal 1-3

for a voltage signal 1-4

Cosine Response 5-1

## F

Factory Recalibration 6-2

Flying Leads 1-2, 2-4

## G

Gain Settings Table 4-3

Gain Settings for the 2420 Amplifier 4-1

## H

Heads, Sensor 6-4

## I

Installing Sensors 2-1

Installing the Base and Cable Assembly 6-3, 6-3

## L

Leveling Sensors 2-1

LI-1400 Datalogger 2-3

LI-1500 Light Sensor Logger 2-3

LI-190R Quantum Sensor 1-1

LI-191R Line Quantum Sensor 1-1

- LI-200R Pyranometer 1-1
- LI-210R-BL Photometric Sensor 2-3
- LI-210R-BNC Photometric Sensor 2-3
- LI-210R-SMV 3-2
- LI-210R Photometric Sensor 1-1
- LI-250A Light Meter 2-3
- Light 1-1
- Light Meter, LI-250A 2-3
- Light Sensor
  - base/cable 1-2
  - specifications A-1
- Light Sensor Amplifier 4-1
- Light Sensors
  - comparing 1-1
  - mounting 2-1
  - spectral response 5-3
- Line Quantum Sensor 1-1
- Logger Compatibility 1-3
- Loggers
  - LI-1500 and LI-1400 2-3

## **M**

- Meter Compatibility 1-3
- Meter, LI-250A 2-3
- Millivolt Adapters 3-1
  - 2290 Millivolt Adapter 3-2
  - 2321 Standard Output 3-2
- Mounting and Levelling Fixture 2-1
- Mounting Sensors 2-1
- Multipliers 2-3
  - for handheld meters 2-2
  - for the 2290 Millivolt Adapter 2-2
  - for the LI-210R-SMV 2-2, 3-2
  - with 3-wire bare leads 2-2

## **P**

- Photometric Sensor 1-1
- Power Supply for the 2420 Amplifier 4-4
- Pyranometer 1-1

## **Q**

- Quantum Sensor 1-1

## **R**

- Radiation 1-1
- Recalibration 6-2
- Removing the Base and Cable 6-3
- Replacement parts 6-4

## **S**

- Sensor Base Cover 6-3
- Sensor Heads 6-4
- Specifications A-1
  - 2420 light sensor amplifier 4-8
- Spectral Response 5-3
- Submersible Quantum Sensors 1-1

## **T**

- Termination Types 1-3

## **V**

- Voltage Signal Options 2-4

## **W**

- Warranty B-1



**LI-COR Biosciences**

***Global Headquarters***

4647 Superior Street  
Lincoln, Nebraska 68504  
Phone: +1-402-467-3576  
Toll free: 800-447-3576  
Fax: +1-402-467-2819  
envsales@licor.com • envsupport@licor.com • www.licor.com/env

***Regional Offices***

**LI-COR GmbH, Germany**

*Serving Andorra, Albania, Cyprus, Estonia, Germany, Iceland, Latvia, Lithuania, Liechtenstein, Malta, Moldova, Monaco, San Marino, Ukraine, and Vatican City.*  
LI-COR Biosciences GmbH  
Siemensstraße 25A  
61352 Bad Homburg  
Germany  
Phone: +49 (0) 6172 17 17 771  
Fax: +49 (0) 6172 17 17 799  
envsales-gmbh@licor.com • envsupport-gmbh@licor.com

**LI-COR Ltd., United Kingdom**

*Serving Denmark, Finland, Ireland, Norway, Sweden, and UK.*  
LI-COR Biosciences UK Ltd.  
St. John's Innovation Centre  
Cowley Road  
Cambridge  
CB4 0WS  
United Kingdom  
Phone: +44 (0) 1223 422102  
Fax: +44 (0) 1223 422105  
envsales-UK@licor.com • envsupport-UK@licor.com

LI-COR Distributor Network: [www.licor.com/env/distributors](http://www.licor.com/env/distributors)

5/15 984-15209

***LI-COR***®